

Dynafite® III

Abrasive Belt Tool

Safety, Operation and Maintenance – Save This Document and Educate All Personnel

Model	RPM	Belt Size
15420	20,000	1/4" or 1/2" x 24"

SANDER

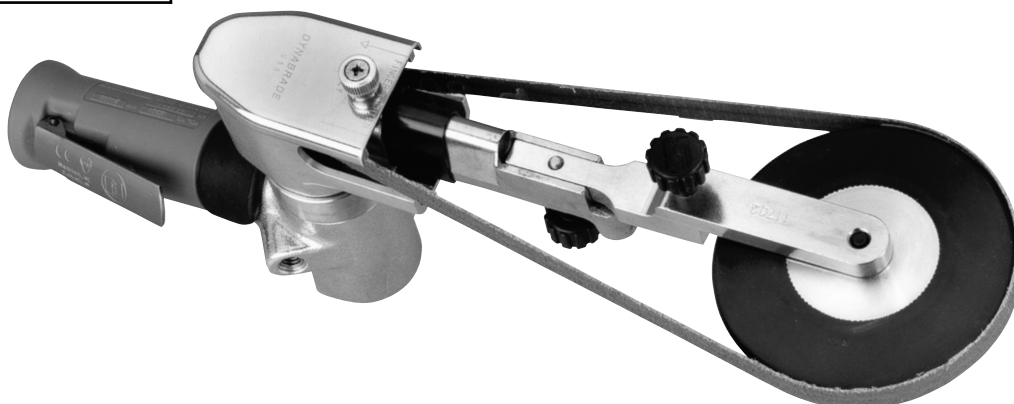

Find The Most Current Offering of Support Documents and Accessories at www.Dynabrade.com

⚠ WARNING

Read and understand this tool manual before operating your air tool. Follow all safety rules for the protection of operating personnel as well as adjacent areas. Always operate, inspect and maintain this tool in accordance with the American National Standards Institute (ANSI). Safety Requirements for the Use, Care and Protection of Abrasive Wheels – ANSI B7.1, Compressed Air and Gas Institute (CAGI) Safety Code for Portable Air Tools – B186.1, Code of Federal Regulation – CFR 29 Part 1910, International Organization for Standardization (ISO) Hand Held Non-Electric Power Tools – ISO 11148, Safety Requirements and applicable State and Local Regulations.



Read and understand tool manual before work starts to reduce risk of injury to operator, visitors, and tool.



Eye protection must be worn at all times, eye protection to conform to ANSI Z87.1.



Ear protection to be worn when exposure to sound, exceeds the limits of applicable Federal, State or local statutes, ordinances and/or regulations.



Practice safety requirements. Work alert, have proper attire, and do not operate tools under the influence of alcohol or drugs.



Respiratory protection to be used when exposed to contaminants that exceed the applicable threshold limit values required by law.



Air line hazard, pressurized supply lines and flexible hoses can cause serious injury. Do not use damaged, frayed or deteriorated air hoses and fittings.

Some dust created by sanding, grinding, drilling, and other construction activities contain chemicals known to cause cancer, birth defects or other reproductive harm. Some examples of these chemicals are:

- Lead from lead-based paints
- Crystalline silica from bricks and cement and other masonry products
- Arsenic and chromium from chemically treated lumber

Your risk from these exposures varies, depending on how often you do this type of work. To reduce your exposure to these chemicals: work in a well ventilated area, and work with approved safety equipment, such as those dust masks that are specially designed to filter out microscopic particles.

SAFETY and OPERATING INSTRUCTIONS



Carefully Read and Understand the General and Sander sections found in Tool Safety and Operating Guidelines (PN00001676) Before Handling or Using Tool.

Carefully Read all instructions before operating or servicing any Dynabrade® Abrasive Power Tool. Products offered by Dynabrade are not to be modified, converted or otherwise altered from the original design.

Tool Intent: Dynafite® III are used for grinding, deburring, blending and polishing on various materials. Tool accepts optional abrasive belts that are 1/4" or 1/2" wide by 24" long.

DO NOT USE Tool for Anything Other Than Its Intended Applications.

Training: Proper care, maintenance, and storage of your air tool will maximize tools performance and reduce chance for accident.

Employer's Responsibility: Provide operators with safety instructions and training for safe use of tools and accessories.

Report to Your Supervisor any Condition of the Tool, Accessories or Operation you Consider Unsafe.

MAINTENANCE INSTRUCTIONS

Important: To keep tool safe, a Preventative Maintenance Program is recommended. The program should include inspection of the tool and all related accessories and consumables, including air lines, pressure regulators, filters, oilers, etc. (refer to CAGI B186.1 for additional maintenance information). If accessory or tool breakage occurs, investigate failure to determine the cause and correct before issuing tool for work. Use the following schedule as a starting point in developing a Preventative Maintenance Program. If tool does not operate properly (RPM, vibration, start/stop) after these scheduled checks or at any time, the tool must be repaired and corrected before returning tool to use.

INSTALLATION



- To ensure long life and dependable service, use a Closed Loop Air System and Filter-Regulator-Lubricator (FRL) as diagramed below.
- Each tool should have its own dedicated hose connected to an air supply FRL. Quick disconnects should be installed at the FRL in an effort to reduce contamination into the tool. Securely affix all fittings and hose assemblies.
- It is strongly recommended that all Dynabrade rotary vane air tools be used with a Filter-Regulator-Lubricator to minimize the possibility of misuse due to unclean air, wet air or insufficient lubrication. Dynabrade recommends the following: **10681** Air Line Filter-Regulator-Lubricator — Provides accurate air pressure regulation, two-stage filtration of water contaminants and micro-mist lubrication of pneumatic components.
- Dynabrade recommends 1 drop of air lube per minute for each 20 SCFM (example: if the tool specification states 40 SCFM, set the drip rate on the filter-lubricator to 2 drops per minute). **95842** Dynabrade Air Lube is recommended.

MAINTENANCE SCHEDULE

Maintenance schedules depend on the type and style of tool. Refer to page 3 to reference symbols associated with specific maintenance items/areas. Match maintenance schedules accordingly. See page 4 for any additional maintenance information.

Note: Turbine style air motors do not require oil.

Daily (every 8 hours):

- Inspect tool and accessories for damage or broken parts. Replace items as necessary to ensure proper operation and safety.
-  Lubricate motor as recommended. Use **95842** Dynabrade Air Lube (10W/NR). Apply 1 drop/minute of air lube per 20 SCFM.
- Check air line pressure with a gage. (MAX. 90 PSIG or 6.2 Bar operating pressure at the air inlet of the tool.)
-  Lubricate wick system and right angle gears through gear case fitting. Apply 3 plunges of **95848** Gear Oil. Use **95541** Lubricant Gun (Prime lubricant gun before use).
- Check tool for proper operation: If operating improperly or demonstrates unusual vibration, the tool must be serviced and problem corrected before further use.

Every 20 Hours/Once a Week (which ever comes first):

- Measure RPM (speed) by setting air pressure to 90 PSIG (6.2 Bar) at tool inlet, without accessory mounted, while the tool is running. Using tachometer, check spindle speed of the tool. Unless otherwise stated the

no-load speed may not exceed the rated speed. If tool speed exceeds maximum rated RPM, service as required and correct before use.

- If tool is running too fast: look for worn, damaged or missing governor, air control rings and silencer(s). Service as required.
- If tool is running too slow: look for malfunctioning governor, clogged inlet screen, silencer(s) or air stream. Service as required.

Note: Special care must be taken when servicing governors. Refer to specific tool manual for governor instructions and/or speed control devices. Governor assemblies made from molded plastic components are non-serviceable and must be replaced.

Every 50 Hours:

-  Lubricate planetary gears through gear case fitting with 3 plunges of **95542** Grease. Use **95541** Lubricant Gun. (Prime lubricant gun before use).

REPAIR

- Use only genuine Dynabrade replacement parts to ensure quality. To order replacement parts, specify Model#, Serial# and RPM of your air tool.
- Mineral spirits are recommended when cleaning the tool and parts. Do not clean tool or parts with any solvents or oils containing acids, esters, ketones, chlorinated hydrocarbons or nitro carbons.
- A Motor Tune-Up Kit is available which includes high wear and medium wear motor parts.
- Air tool markings must be kept legible at all times, if not, reorder housing and replace. User is responsible for maintaining specification information.

-  After maintenance is performed on tool, add a few drops of **95842** Dynabrade Air Lube to the tool inlet and start the tool a few times to lubricate air motor. Verify RPM (per 20 hr maintenance schedule), vibration and operation.

HANDLING & STORAGE

- Use of tool rests, hangers and/or balancers is recommended.
- Protect tool inlet from debris (see Notice below).
- **Do Not** carry tool by air hose or near the tool throttle lever.
- Store accessories in protective racks or compartments to prevent damage.
- Follow the handling instructions outlined in the operating instructions when carrying the tool and when changing accessories.
- Protect accessories from exposure to water, solvents, high humidity, freezing temperature and extreme temperature changes.

END OF USE/DISPOSAL

When tool has reached its end of useful service, disassemble tool into its primary components (i.e. steel, aluminum and plastic) and recycle or discard per local, state and/or federal regulations as to not harm the environment.

NOTICE

All Dynabrade air motors use the highest quality parts available and are manufactured to exacting tolerances. Air motor failures are often traced to lack of lubrication or unclean air supply. Compressed air can force dirt and other contaminants into motor bearings causing early failure. Contaminants can score cylinder wall and vanes resulting in reduced efficiency and power. Our warranty obligation is contingent upon proper use of our tools. Air motors which have been subjected to misuse, contaminated air or lack of lubrication will void warranty.

CLOSED LOOP AIR SYSTEM

Sloped in Direction of Air Flow

- Dynabrade Air Power Tools are designed to operate at 90 PSIG (6.2 Bar) maximum air pressure at the tool inlet, when the tool is running. Use recommended regulator to control air pressure.
- Ideally the air supply should be free from moisture. To facilitate removing moisture from air supply, the installation of a refrigerated air dryer after the compressor and the use of drain valves at each tool station is recommended.

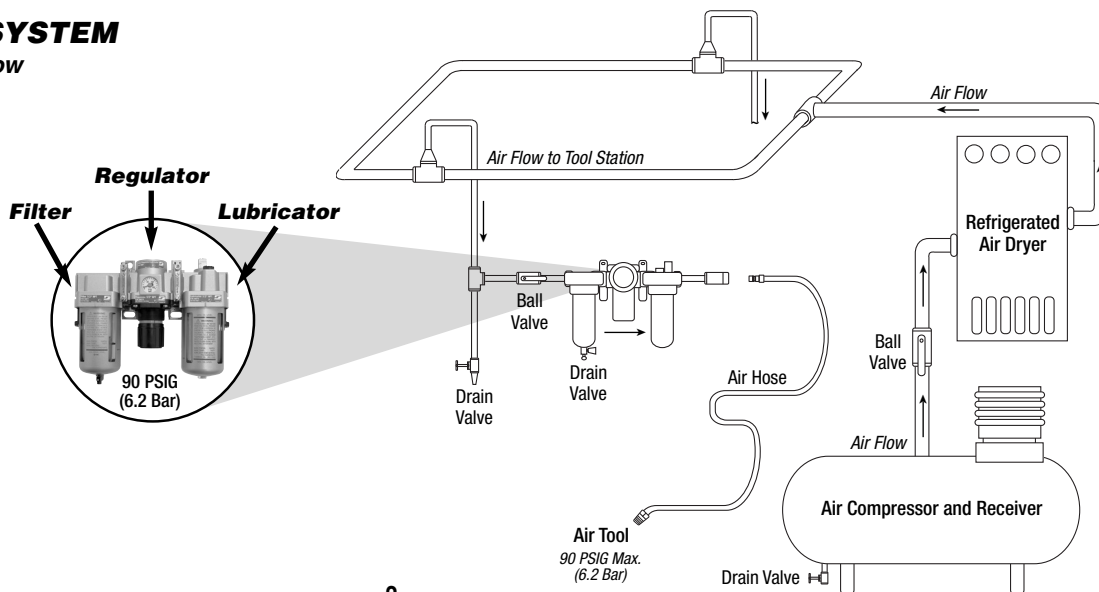

Lubricator Setting

1 Drop/Minute per 20 SCFM

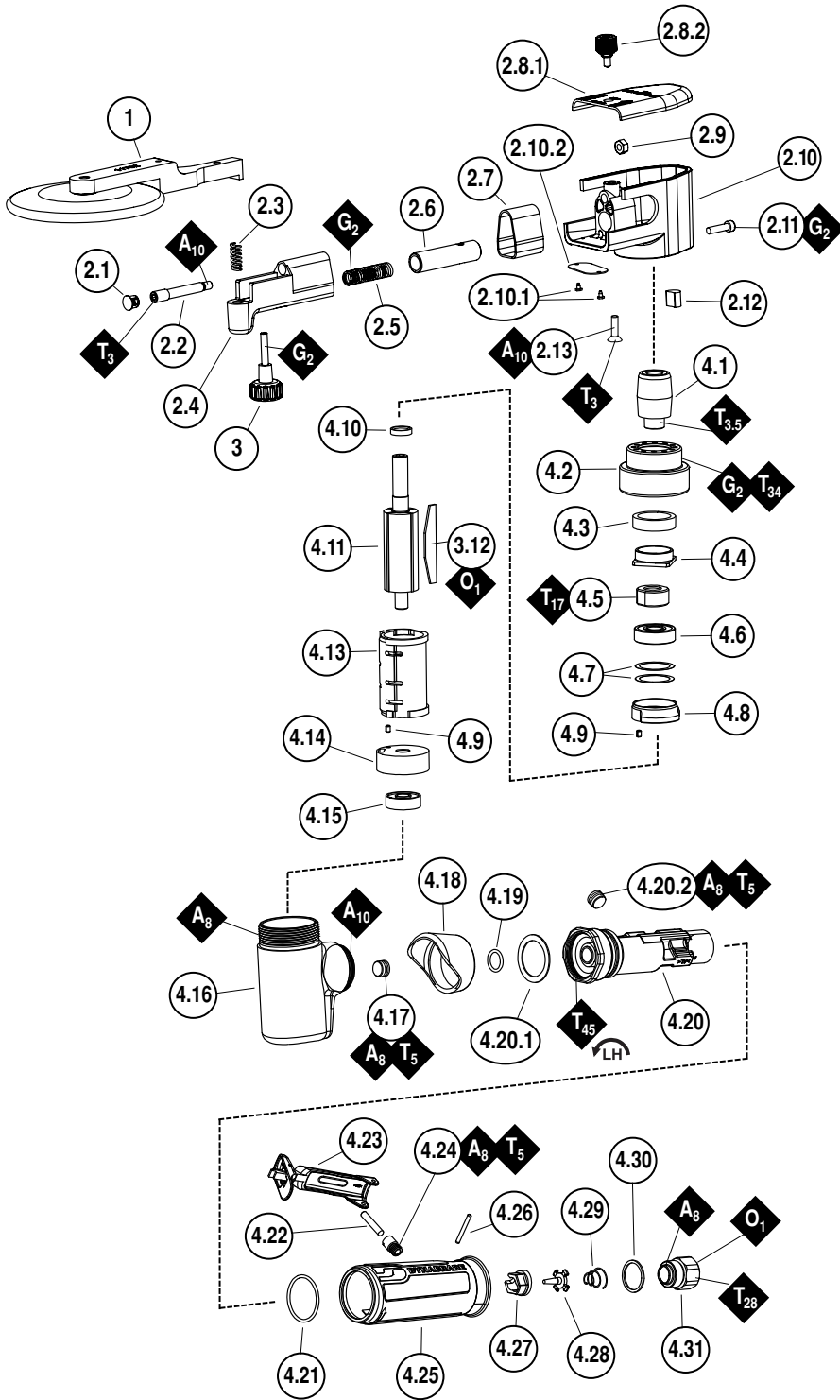

ITEM	P/N	DESCRIPTION	QTY.
1	11702	CONTACT ARM	1
2	15127	HOUSING ASSEMBLY	1
2.1	96334	PLUG	1
2.2	15308	GUIDE POST	1
2.3	11040	SPRING	1
2.4	15306	TENSION ARM	1
2.5	95426	SPRING	1
2.6	15307	TENSION SHAFT	1
2.7	15309	DUST COVER	1
2.8	15124	BELT GUARD ASSEMBLY	1
2.8.1	15123	BELT GUARD	1
2.8.2	15329	SCREW	1
2.19	96335	NUT	1
2.10	15126	HOUSING	1
2.10.1	95442	SCREW	2
2.10.2	15396	LABEL	1
2.11	95311	SCREW	1
2.12	40029	MOTOR LOCK	1
2.13	95217	SCREW	1
3	95218	KNOB	1
4	15391	MOTOR ASSEMBLY	1
4.1	15336	DRIVE WHEEL	1
4.2	15315	EXHAUST COVER	1
4.3	15322	FELT SILENCER	1
4.4	15314	AIR CONTROL	1
4.5	01708	ROTOR NUT	1
4.6	01007	BEARING	1
4.7	01121	SHIM PACK (3/PKG)	1
4.8	01008	FRONT BEARING PLATE	1
4.9	50767	PIN	2
4.10	01010	SPACER	1
4.11	55025	ROTOR	1
4.12	01185	VANE SET (4/PKG)	1
4.13	01028	CYLINDER	1
4.14	01743	REAR BEARING PLATE	1
4.15	02649	BEARING	1
4.16	01739	HOUSING	1
4.17	01437	PLUG	1
4.18	01558	COLLAR	1
4.19	95523	O-RING	1
4.20	45309	THROTTLE BODY ASSEMBLY	1
4.20.1	01548	GASKET	1
4.20.2	01437	PLUG	1
4.21	96077	O-RING	1
4.22	97045	PIN	1
4.23	45263	THROTTLE LEVER ASSEMBLY	1
4.24	45315	BUSHING	1
4.25	09623	SLEEVE	1
4.26	97060	PIN	1
4.27	45310	SEAL	1
4.28	58365	TIP VALVE	1
4.29	01468	SPRING	1
4.30	01564	SPACER	1
4.31	01494	INLET BUSHING	1

KEY

O Oil: O₁ = Air Lube

G Grease: G₂ = Loctite® #771

A Adhesive: A₈ = Loctite® #567
A₁₀ = Loctite® #243

Always follow adhesive manufacturers cleaning and priming recommendations.

KEY

T_x X = Torque Value (N•m)

T Torque: N•m x 8.85 = lb•in.

LIFETIME WARRANTY

To validate Dynabrade Lifetime Warranty, you must register each tool at: www.dynabrade.com. Registration of each tool at website is required. Dynabrade will not honor Lifetime Warranty on unregistered tools. Please view the entire Lifetime Warranty Policy at : www.dynabrade.com.



MACHINE SPECIFICATIONS

Model	Speed	Power	Sound	Air Consumption	Belt Size	Weight	Length	Height
15420	20,000 RPM	.7 hp (522 W)	84 db(A)	37 SCFM (1,042 LPM)	1/4" or 1/2" W x 24" L	2.8 lb. (1.3 kg)	16" (410 mm)	5.8" (146 mm)

Additional Specifications: Air Inlet Thread 1/4" NPT • Hose I.D. 3/8" (10 mm)

Sound Level is the pressure measurement according to the method outlined in ISO regulation ISO-15744

OPTIONAL ACCESSORIES



Motor Tune-Up Kit

- Includes assorted parts to help maintain and repair motor.

Part No. 96233



Dynabrade Air Lube

- For pneumatic equipment.
- Absorbs up to 10% of its weight in water.
- Prevents rust and formation of sludge.

Part No. 95821 4 oz.

Part No. 95842 1 pt.



"Mega Flow" Plug

- Provides up to twice the air flow compared to standard plug design.
- Plug has "ported" design to prevent "starving" of the air tool.

Part No. 95675 Male



Dynaswivel®

- Composite construction.
- 1/4" NPT.
- Swivels 360° at two locations which allows an air hose to drop straight to the floor.

Part No. 94300

REFERENCE CONTACT INFORMATION

American National Standards Institute (ANSI)

1899 L Street, NW, 11th Floor • Washington, DC 20036
Tel: 1 (202) 293-8020

Compressed Air & Gas Institute (CAGI)

1300 Sumner Ave. • Cleveland, OH 44115-2851
Tel: 1 (216) 241-7333 • Fax: (216) 241-0105

Government Printing Office (GPO)

Superintendent of Documents • Attn: New Orders
P.O. Box 371954 • Pittsburgh, PA 15250-7954 • Tel: 1 (202) 512-1803

International Organization of Standards (ISO)

Case postale 56 • CH-1211 Geneva 20
Tel: + 41 22 749 01 11 • Fax: + 41 22 749 09 47

DYNABRADE, INC.

8989 Sheridan Drive • Clarence, NY 14031-1419 • Phone: (716) 631-0100 • Fax: 716-631-2073 • International Fax: 716-631-2524
©DYNABRADE, INC., 2014

www.dynabrade.com



PD14.24_10/14